

## Properties of biophotons and their theoretical implications

Fritz-Albert Popp\*

International Institute of Biophysics, Ehem.Raketenstation, Kapellener Straße o.N., D-41472 Neuss, Germany

The word "biophotons" is used to denote a permanent spontaneous photon emission from all living systems. It displays a few up to some hundred photons  $/(s.cm^2)$  within the spectral range from at least 260 to 800 nm. It is closely linked to delayed luminescence (DL) of biological tissues which describes the long term and ultra weak reemission of photons after exposure to light illumination. During relaxation DL turns continuously into the steady state biophoton emission, where both, DL and biophoton emission exhibit mode coupling over the entire spectrum and a Poissonian photo count distribution. DL is representing excited states of the biophoton field. The physical properties indicate that biophotons originate from fully coherent and sometimes even squeezed states. The physical analysis provides thermodynamic and quantum optical interpretation, in order to understand the biological impacts of biophotons. Biological phenomena like intracellular and intercellular communication, cell growth and differentiation, interactions among biological systems (like "Gestaltbildung" or swarming), and microbial infections can be understood in terms of biophotons. "Biophotonics", the corresponding field of applications, provide a new powerful tool for assessing the quality of food (like freshness and shelf life), microbial infections, environmental influences and for substantiating medical diagnosis and therapy.

**Keywords:** Biophoton, Delayed luminescence, Photo count statistics, Superradiance, Coherence, Communication, Squeezed state

### Introductory Remarks

As an outstanding developmental biologist of the third decade of the 20th century, the Russian scientist Alexander Gurwitsch<sup>1,2</sup> tried to solve one of the most crucial problems of biology, i.e. the "Gestaltbildungs"-problem, which is the question of how living tissues transform and transfer information about the size and shape of different organs. Chemical reactions do not contain spatial or temporal patterns *a priori*. That was the reason why Gurwitsch looked for a "morphogenetic field" which could regulate cell growth and differentiation. In particular, in his so-called "Grundversuch" ("basic experiment"), he found ample indication for the involvement of photons in the stimulation of cell division. Fig. 1 displays this famous "Grundversuch" of A. Gurwitsch.

He used the stem of an onion root as a "detector" and the tip of another one, very near to the detector but not actually touching it, as an "inductor". The subject of observation was the cell division rate at just the region of the stem where the tip pointed onto it. It turned out that the cell growth on this region of the stem did not change in the case of normal "window glass" being squeezed between inductor and detector.

However, as soon as the window glass was substituted with a quartz glass plate (which is transparent for UV light of about 260 nm), the cell division rate (number of mitoses) increased significantly. Gurwitsch interpreted this effect as the mitotic activity of single photons of about 260 nm, triggering cell divisions. He called this photon emission from biological systems "mitogenetic radiation" and repeated the experiments successfully also with other biological systems, e.g., yeast.

However, despite confirmation of his results, also shown in a paper by the later Nobel laureate D. Gabor<sup>3</sup>, the scientific community forgot Gurwitsch's work in view of (i) some (unessential) objections that came

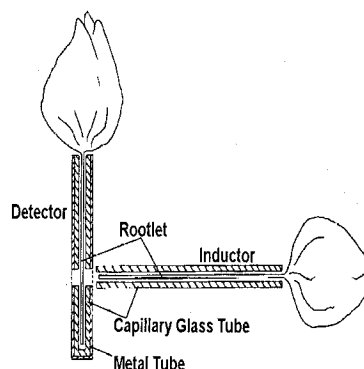

Fig. 1—Arrangement of Gurwitsch's experiment with onion roots.

\*E-mail: a0221@rrz.uni\_koeln.de

iib@lifescientists.de

Fax: 02182-825132

Phone: 02182-825131

up, (ii) the rather difficult experimental work in this field involving the lack of appropriate photon counting systems, and (iii) a fast developing biochemistry which tried to explain cell growth in terms of hormones and similar biomolecules. "Mitogenetic radiation" was therefore considered some kind of artifact.

After World War II, technical devices for measuring single photons improved through the development of photomultipliers. Russian biophysicists, and others, too, confirmed the existence of a "dark luminescence" of all living systems in the visible range, which could not be explained in terms of heat radiation. The rather viable work of the Russian groups who published mainly in the Russian journal *Biophysics* (translated in the USA) has been reviewed by Ruth<sup>4</sup>. However, about 1970 the Russians stopped their activities in this field and turned to more practical questions about photosynthesis. Apart from biochemists in Poland around the researcher Slawinski<sup>5</sup>, the Russian work received almost no attention.

In the Western world "low-level luminescence" of living systems did not ever become a serious subject of fashionable science. With the exception of groups around Inaba (Japan)<sup>6</sup>, Boveris (USA)<sup>7</sup>, and Quickenden (Australia)<sup>8</sup>, this phenomenon of single photons from active biological tissues was completely disregarded or even disreputed. In cases where this non-thermal photon emission has been accepted at all, the common opinion reflected the statements of the Russian biophysicist Zhuravlev<sup>9</sup> and the American chemist Seliger<sup>10</sup>, i.e. their hypothesis that "weak bioluminescence" originates from "imperfections" in metabolic activity. This means that occasionally photons should be emitted since the living system is in the situation of a permanent excited state subject to falling back into thermal equilibrium. Under these conditions, some scientists considered to be obvious that highly reactive compounds such as radicals and oxidation reactants are the most likely candidates for photon sources.

There are other biological phenomena that could have led to the realization that photons exist in living cells<sup>11-18</sup>. One is the well-known fact that about  $10^5$  chemical reactions per cell/per sec take place. Without electronic excitation of at least one of the reaction partners, it would be impossible, and the number of thermal photons in the tiny reaction volume of a cell could never suffice to explain this high reaction rate. At least a  $10^{14}$  higher photon

density in the optical range is necessary to provide this huge amount of chemical reactivity. Another point is the famous Erwin Schrödinger's question concerning the surprisingly small number of aberrations in the migration of biomolecules during cell division. Let us look, for example, at the mitotic figures of a cell in mitosis (Fig. 2, left side).

The only plausible answer to this question is the presence of cavity resonator waves (Fig. 2, right side), which also provide the necessary stability of the molecular arrangements as the guiding forces for their movement. We calculated roughly the character of some transverse magnetic and electric modes and their wavelengths under the particular boundary conditions and for the dimensions of a cell, which may work as a conducting or dielectric resonant cavity (or both). Table 1 displays the list of results<sup>19</sup>, where the eigenvalues of the Bessel functions  $m$ ,  $n$  correspond to the radial axis and  $p$  to the length of a right circular cylindrical cavity.

The resonance wavelengths are in the optical range between 300 and 700 nm. We show in Table 1 that the dynamical structures of the mitotic figures during cell division can be obtained by superposition of cavity resonator waves of this kind. It indicates that the electromagnetic forces of these patterns present the most likely answer to Schrödinger's question of why the error rate vanishes.

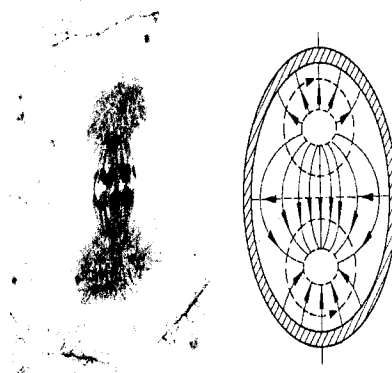

Fig. 2—Left side. Completely developed spindle apparatus of a fish (*Corregonus*) in mitosis. (From: Darlington, C.D., Lacour, L.F.: *The Handling of Chromosomes*. Allen and Unwin, London, 1960).

Right side. Electric field of  $TM_{11}$  cavity modes in a right circular cylindrical cavity. Comparison with Fig. 8 left side shows that mitotic figures are striking examples of long-lasting photon storage and coherent fields within biological systems. (From: Popp, F.A.: *Photon Storage in Biological Systems*, In: *Electromagnetic Bio-Information*, Urban & Schwarzenberg, Muenchen-Wien-Baltimore 1979).

Table 1 — Modes of a cylindrical cavity of same dimensions as typical cells

TE mode mnp	TM mode mnp	Wavelength $\lambda/nm$	Number of stored photons $(E_0^2 \cdot \epsilon \cdot V_{res} / (8\pi)) \cdot 10^{10} \text{ erg}$
111		690	4,900
	010	574	7,787
112		571	5,929
	011	546	4,099
	012	481	4,655
113		462	7,323
211		438	1,589
	013	410	5,451
212		402	1,730
114		379	8,910
	110	360	2,939
213		358	1,943
011	111	353	3,004
	014	349	6,407
012	112	333.5	3,181
311		323	0,778
115		318	10,606

It is evident that there is no workable way to measure these quasi-standing light waves directly within the intracellular space. However, if one puts a sufficiently high sensitive photomultiplier in front of the living tissue, then one expects to measure at least single photons in the visible range which should display spatial and temporal correlations to biological functions, i.e. cell growth.

In agreement with these considerations, around 1970 my interdisciplinary group of physicists, biologists and physicians at the university in Marburg (Germany) found significant correlations between some optical properties of biomolecules (including polycyclic hydrocarbons) and their biological efficacy (including carcinogenic activity)<sup>11-14</sup>. The basic question came up whether the excited states of biomolecules could be responsible for the light emission in biological tissues or whether a photon field in living systems is the regulator for the excitation of the biological matter. This problem is similar to the question "Which came first? The chicken or the egg?"

In contrast to the purely biochemical point of view, this search for the original regulator could be approached in terms of information transfer in biological systems supported by increasing understanding of quantum optics, in particular in the non-classical range. First, I will confine myself to the most essential experimental results that have been obtained from this time on by careful investigation of "low-level luminescence" or, as we have called this phenomenon, "biophotons" Then, I will show that the

more physical basis of interpretation provides a rather consistent picture of this universal phenomenon of weak photon emission from living systems. Last, some theoretical implications will be discussed.

### Measurements of essential properties of biophotons

Biophotons are measured by detectors based on photomultiplier techniques. These instruments provide both high sensitivity and resolution. Our single photon counting system functions at a sensitivity of about  $10^{17}$  W and a signal-to-noise ratio of at least 10. The cathode of an EMI 9558 QA photomultiplier is sensitive within the range of 200 to 800 nm. The noise is reduced by inserting the multiplier into a cooling jacket, where copper wool provides thermal contact. In addition, a grounding metal cylinder protects the multiplier from electric and magnetic fields. In order to prevent the multiplier from freezing, the whole tube together with the cooling jacket is kept in a vacuum. Thus, the quartz glass in front of the multiplier tube has no thermal contact with the cooled cathode and cannot become covered with moisture. An optimal cooling temperature is produced at about  $-30^\circ\text{C}$ . With the use of a chopper, the equipment is able to register a real current density of 2 photons/(s  $\text{cm}^2$ ) at a significance level of 99.9% within 6 hr. A detailed description of the method has been presented elsewhere<sup>4</sup>. Fig. 3 displays an implementation of the equipment.

We report here only results that have been reproduced several times, and that have been confirmed by different groups. Thus, the essential characteristics of biophoton emission may be summarized as follows<sup>15-17</sup>:

- The total intensity  $i$  from a few up to some hundred photons/(s  $\text{cm}^2$ ) indicates that the phenomenon is quantum physical, since fewer than about 100 photons are ever present in the photon field under investigation.
- The spectral intensity  $i(\nu)$  never displays small peaks around definite frequencies  $\nu$ . Rather, the quite flat spectral distribution has to be assigned to a non-equilibrium system whose excitation temperature  $\vartheta(\nu)$  increases linearly with the frequency  $\nu$ . This means that the occupation probability  $f(\nu)$  of the responsible excited states does not follow a Boltzmann distribution  $f(\nu) = \exp(-h\nu/kT)$  but the rule  $f(\nu) = \text{constant}$  (Fig. 4).
- The probability  $p(n, \Delta t)$  of registering  $n$  biophotons ( $n=0,1,2,\dots$ ) in a preset time interval  $\Delta t$  follows

under ergodic conditions surprisingly accurately a Poissonian distribution ( $\exp(-\langle n \rangle) \langle n \rangle^n / n!$ , where  $\langle n \rangle$  is the mean value of  $n$  over  $\Delta t$ . This holds true at least for time intervals  $\Delta t$  down to  $10^{-5}$  s. For lower time intervals  $\Delta t$  there are no results known up to now<sup>18</sup> (Fig. 5).

- After excitation by monochromatic or white light, the “delayed luminescence” of every biological system relaxes quite slowly and continuously down to “spontaneous” biophoton emission, not according to an exponential function, but with a strong relationship to a hyperbolic-like ( $1/t$ ) function, where  $t$  is the time after excitation (Fig. 6).
- The optical extinction coefficient of biophotons passing through thin layers of sea sand and soya cells of various thickness can have values of at least one order of magnitude lower than that of artificial light with comparable intensity and spectral distribution, indicating that this difference cannot be explained in terms of wavelength dependence on extinction<sup>20</sup>.
- The biophoton emission displays the typical temperature dependence of physiological functions, such as membrane permeability,

glycolysis, and many others. This means that with increasing temperature one gets overshoot reactions, while with decreasing temperature an undershoot response may take place. The resulting “temperature hysteresis loops” of biophoton emission (Fig. 7) can be described by a Curie-Weiss law dependence<sup>21</sup>.

- Reactions to stress are frequently indicated by an increase in biophoton emission.

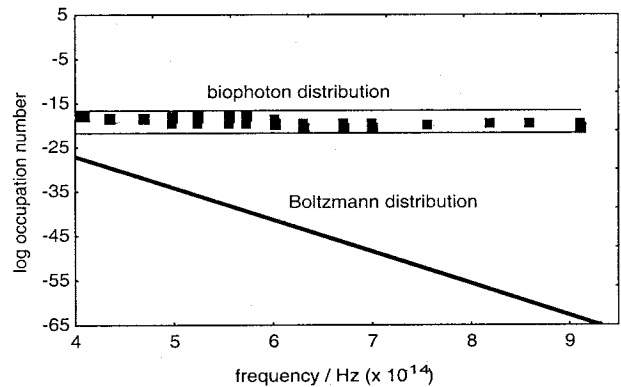

Fig. 4— In the case of average occupation numbers we obtain a  $f = \text{const.}$ -distribution that with increasing frequency displays increasing deviation from the Boltzmann-distribution.

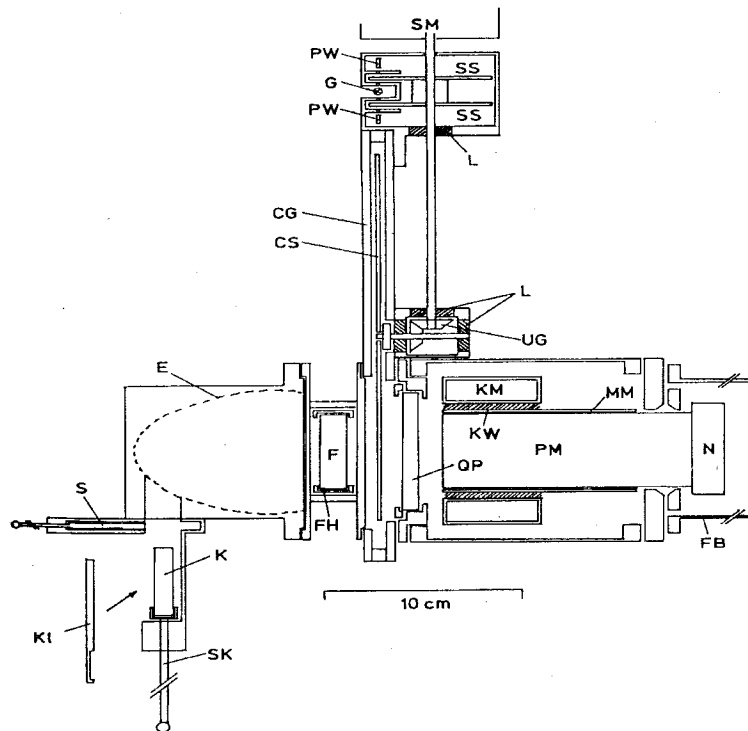

Fig. 3— The measuring equipment. PM –photomultiplier; CS–disc of the chopper; CG–housing of the chopper-disc; E–ellipsoid; F–filters; FB–faraday cup; FH–filter holder; G–lamp; K–test quartz glass; KI–flap; L–ball bearing; KM–cooling jacket; KW–Copper wool; MM–metal cylinder; N–network; PW–photosensitive resistor; QP–quartz glass; S–slide to close the ellipsoid; SK–rod to move up the test glass; SM, UG–geared motor; SS–sector-discs.

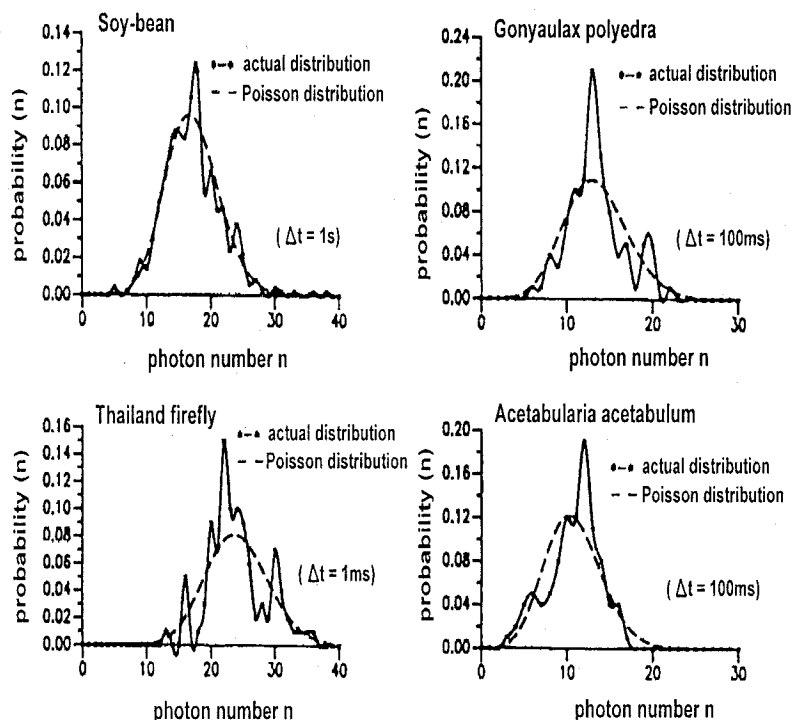

Fig. 5—The photocount statistics (=probability  $p(n, \Delta t)$  of registering  $n$  counts in a preset time interval  $\Delta t$ , where  $n=0, 1, 2, \dots$ ) is very similar for all biological systems. If  $\Delta t$  is sufficiently small such that the mean number of photons in the field becomes lower than about 100,  $p(n, \Delta t)$  displays a Poissonian (and sometimes even a sub-Poissonian) photocount distribution. There are 4 different examples with different  $\Delta t$ . 100 measurement values have been used always for evaluation, where the biological state was kept quasi-stationar.

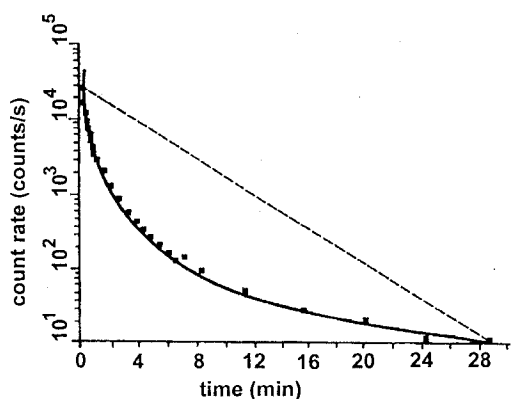

Fig. 6—Instead of an exponential decay (dashed line), living cell populations (here tissue of *Bryophyllum daigremontanum*) exhibit a hyperbolic relaxation of photon intensity after exposure to white-light-illumination. This holds for total as well as for spectral observation (here at  $676 \pm 10$  nm). Under ergodic conditions, hyperbolic decay is a sufficient condition of perfect coherence.

- There is evidence that the conformational states of DNA influence biophoton emission. This has been demonstrated, for instance, by the intercalation of ethidium bromide (EB) into DNA (Fig. 8) According to the upwinding and renewed unwinding of DNA by increasing concentrations of EB, the biophoton emission intensifies and drops down in a rather strong cor-

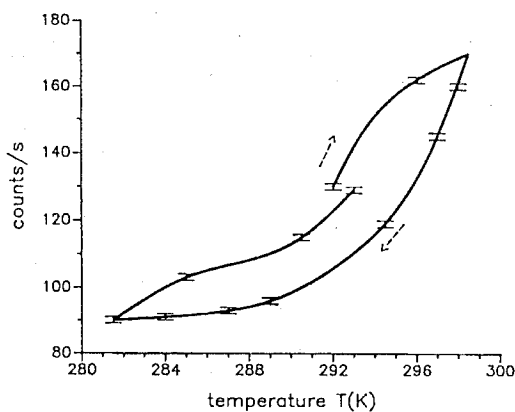

Fig. 7—The biophoton intensity of living tissues shows a hysteresis-like dependence on the temperature  $T$ , if  $T$  is cyclically varied. The example shows etiolated barley, 4 days of germination. The variation of temperature starts at  $T=292$ K with the rate  $\partial T/\partial t=0.5$ K/min. At  $T=298.5$ K the rate of temperature change is reversed to  $\partial T/\partial t=-0.5$ K/min, and again at  $T=281.5$ K with  $\partial T/\partial t=0.5$ K/min. This hysteresis-like behaviour of biophoton intensity can truthfully be described as a Curie-Weiss-law-dependence.

relation. This and other results indicate that chromatine is one of the most essential sources of biophoton emission<sup>22,23</sup>.

The Poissonian distribution of photocount statistics  $p(n, \Delta t)$  under ergodic conditions together with the

hyperbolic relaxation function of delayed luminescence is a sufficient condition of a fully coherent photon field<sup>24</sup>.

Thus, we can conclude that biophotons originate from a coherent field. Before we discuss the theoretical aspects, let us look at some biological phenomena for which there is a rather plausible explanation but which cannot be understood in terms of common molecular biology.

**Biological impacts**

Once the coherence of biophotons is accepted, it is not difficult to predict a variety of biological phenomena, which deviate considerably from the “conventional” point of view, thus providing a reliable basis for examining the theory and for obtaining a more profound understanding of biology.

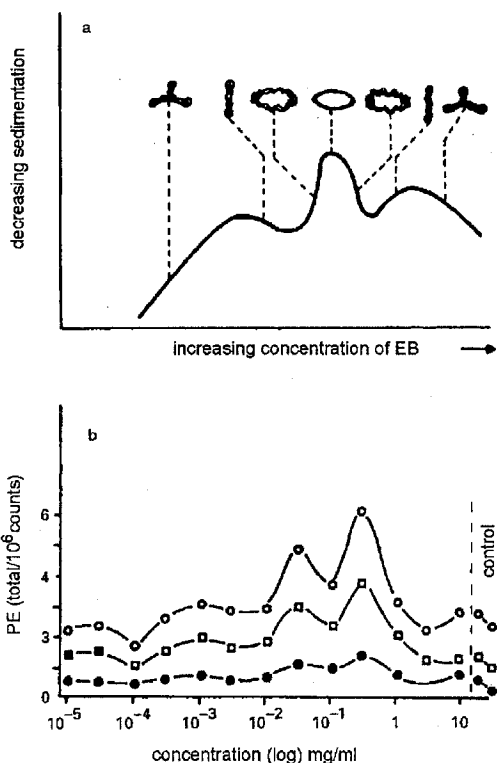

Fig. 8—(a) The more ethidiumbromide (EB) is added, the more EB-molecules are inserted between the base pairs of DNA. This intercalation leads to the unfolding of the helix structures of the DNA. The degree of this unfolding is experimentally determined by the sedimentation of the DNA. After complete unfolding further insertion of EB leads to a new upwinding of the DNA helix in the opposite direction. (b) The observation of the biophoton emission after adding EB shows (lower curve: after 1 hour) that the intensity displays the same dependence on the concentration as in (a). This typical profile becomes even more evident after longer measurement time (middle curve: after 3 hours; upper curve: after 5 hours) which indicates a dependence of the biophoton emission on the spatial structure of DNA.

It is evident that coherent fields give rise to destructive and constructive interference, where with respect to energy conservation law zones of destruction have to be compensated for by zones of construction (Fig. 9). According to the theory of R. Dicke<sup>25</sup>, there is a preference for constructive interference (“super-radiance”) in the initial phase of the interaction between radiation and non-randomly oriented matter of suitable size, while destructive interference (“sub-radiance”) dominates after longer periods of time. Consequently, there is always a considerable probability of destructive interference of the biophoton emission of living systems in the space between the living cells.

This means that the biophoton intensity of living matter cannot increase linearly with the number of units, but has to follow the effective amplitudes of the interference patterns of the biophoton field between living systems.

A striking example is the measurements on daphnia<sup>26,27</sup>.

*Daphnia magna* Strauss were put in darkness into water at 18°C within the quartz cuvette of the biophoton measuring equipment. We altered the numbers n of daphnia from 1 to 250, always selecting animals of about equal size. After each alteration the intensity of the biophoton emission was registered. Since every one of the inbred animals emits almost the same intensity, one expects a dependence of biophoton intensity on the number of animals like that displayed in Fig. 10a. After correction for self absorption, it should not significantly deviate from that of Fig. 10a. However, careful measurements showed evidence of the results displayed in Fig. 10b.

The results from interference patterns of biophotons between the animals under investigation

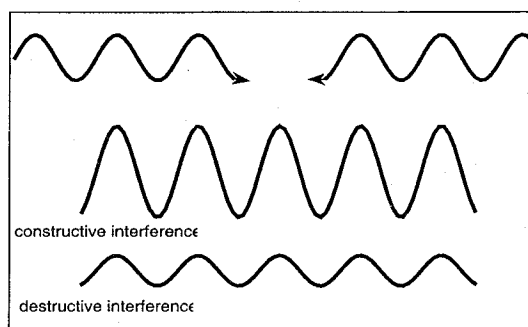

Fig. 9—If two waves interfere, the phase relations will lead in general to zones where they amplify mutually (“constructive interference”) or alternate (“destructive interference”). For coherent fields, these processes provide a basis of regulation and communication.

were as expected. There is a tendency for destructive interference resulting in a lower intensity than expected from the linear increase. The most efficient destruction of the biophoton field outside of the animals is obtained at about 110 animals, corresponding to the population density of daphnia in free nature. This zone of most efficient destruction according to the energy conservation law is at the same time the zone of highest efficacy in "storing" light within the animals.

To some extent one is justified in saying that living systems "suck" the light away in order to establish the most sensitive platform of communication. A more detailed description of this phenomenon has been presented elsewhere<sup>28</sup>. Actually, this biocommunication by means of mutual interference of the biophoton field provides necessary information about the equality or difference of species, since similar animals have similar wave patterns. The signal/noise ratio becomes optimized as soon as the wave patterns interfere under maximum destruction between the communicating systems, since every perturbation

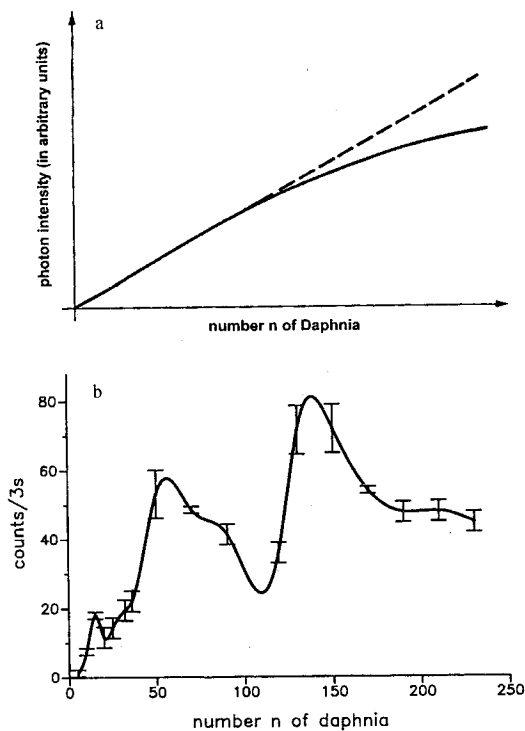

Fig. 10—(a) In case that photon emission from daphnia is dependent on mutual interactions of the animals one expects a linear increase with increasing number of daphnia. This linearity will show a small decline for a large number of animals as soon as self-absorbance has to be taken into account. (b) Mean values of the photon intensity of adolescent daphnia in 15 ml volume with the weighted standard deviation.

leads then to an increase (signal) that the connected systems have to become aware of.

This rather ingenious means of biocommunication provides the basis for orientation, swarming, formation, growth, differentiation, and "Gestaltbildung" in every biological system<sup>17</sup>.

On the other hand, as soon as this capacity for coherent superposition of modes of the biophoton field (where longer wavelengths may also be included) breaks down, in the first stage of destruction one expects consequently an increase in biophoton emission (or delayed luminescence) with increasing numbers of living units within a biological population. This was first confirmed by Schamhart and Van Wijk<sup>29</sup> (Fig. 11) and Scholz *et al.*<sup>30</sup> (Fig. 12). Actually, tumor cells lose the capacity for destructive interference according to their loss of coherence. At the same time, delayed luminescence turns from the hyperbolic-like relaxation of normal cells to the exponential one of tumor cells.

A further striking example is the synchronous flickering of dinoflagellates (Fig. 13).

As soon as these animals see each other, their bioluminescent flickering decreases and displays significantly more synchronous light pulses than in the case when they are separated from each other<sup>31</sup>. This phenomenon can be explained in terms of chemically amplified biophoton emission (which is called "bioluminescence"), establishing destructive interference as soon as the animals "see each other" and displaying synchronous pulses as a consequence of the disruption of the destructive interference patterns.

Even bacteria seem to use this kind of "communication" within their nutrition media<sup>32</sup>. Fig. 14

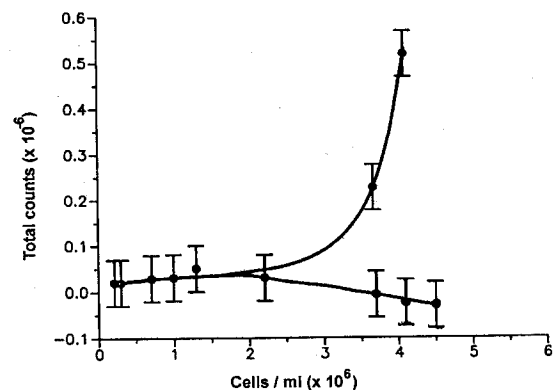

Fig. 11—"Delayed luminescence" from tumor cells (upper curve) and normal cells (lower curve), as measured by Schamhart. The different curves can be approximated by a non-linear (cubic) dependence of intensity from cell-number n.

displays one of the measurements on *Enterococcus faecalis*. Growing bacteria emit such low biophoton intensity that it cannot be registered, in contrast to the permanent photon emission of their nutrition media. (It is impossible, by the way, to produce nutrition media without spontaneous photon emission,

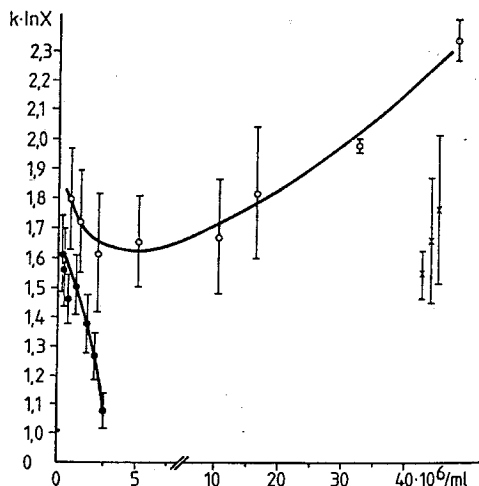

Fig. 12—The decay parameter of the hyperbolic approximation that is adjusted to the relaxation dynamics of the afterglow of different cell suspensions after exposure to weak white light illumination is shown versus cell density. The lower curve displays the improvement of hyperbolic relaxation of normal amnion cells with increasing cell density. The upper curve shows the opposite dependence exhibited by malignant Wish cells. The three measurements at the right side of the figure correspond to the nutritive medium alone.

originating from oxygenation processes). At a definite number of bacteria, the total intensity of the system drops down as a consequence of active photon absorption of the bacteria within the medium. It may happen then that at higher numbers of bacteria this absorbance disappears.

Again, the destructive interference of bacteria within the coherence volume of the light-emitting nutrient molecules provides an explanation for this obviously rather universal process in living nature.

It should be noted that growth regulation through biophoton emission has to follow a law where in addition to linear stimulation ( $\dot{n} \propto n$ ) a nonlinear inhibition ( $n \propto n^2$ ) has to take place. Consequently, the correlation between growth rate and biophoton emission should be based on such a relationship. Fig. 15, as a result of measurements, confirms this connection.

Recently, it has been shown experimentally that in accordance to presumptions of Bajpai<sup>33</sup>, Gu and Li<sup>17</sup>, living systems are even able to emit squeezed light<sup>34</sup>. This leads to a lot of new grounds for establishing the theoretical basis of biophoton emission.

### Theoretical approach

The theory of biophoton emission refers to classical electrodynamics and thermodynamics but also to quantum theory. Experimental starting points

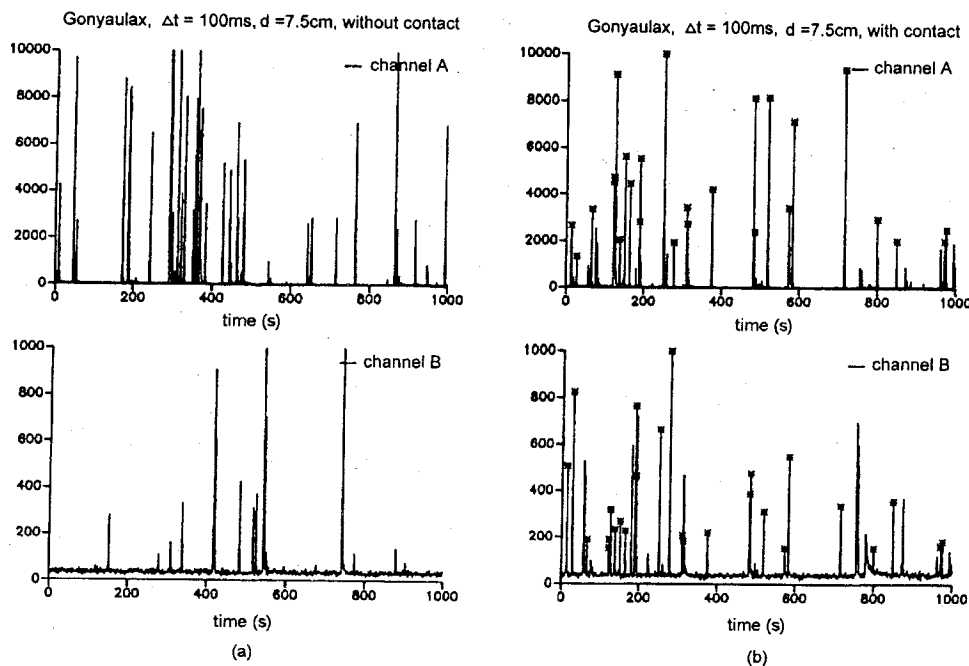

Fig. 13—If ones separates two cultures of dinoflagellates, their bioluminescence flickering is completely unsynchronous (left side). As soon as they are in optical contact, a big amount of flickering is synchronous (right side). The stars indicate the synchronous flashes.



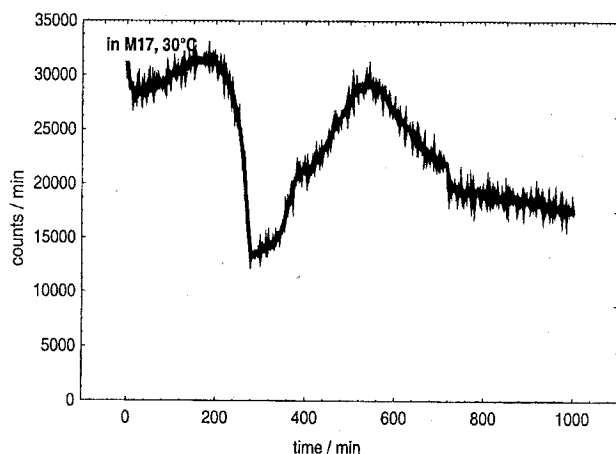

Fig. 14—Growing bacteria in culture medium which by oxidative reactions always emit light absorb from a definite density on the light of the medium. For higher densities this absorbance may decrease.

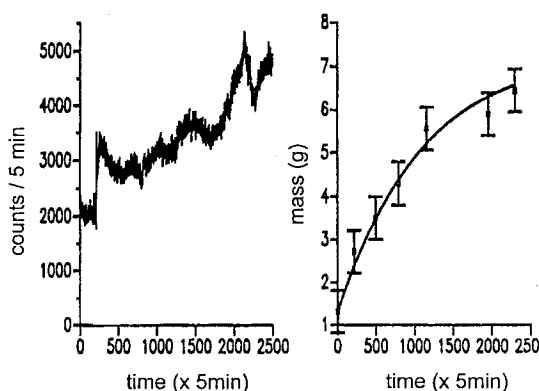

Fig. 15—The biophoton intensity from 9 soy-seeds increases during germination in darkness as shown in the left figure. The mass  $m$  during germination increases according to the curve in the right figure, where the measured values (points with error bars) have been approximated by the growth curve  $m = A/(B+(1-B)\exp(-Ct))$ , with  $A = 1.3\text{g}$ , corresponding to the mass of 9 soy-seeds,  $B=0.178$   $C=2.6 \cdot 10^{-4}(\text{min}^{-1})$ ,  $t$  representing the time.

of the theory are: (1) the spectral intensity of biophoton emission and its temperature behavior<sup>15,21</sup>, (2) the photocount statistics<sup>15</sup>, (3) the hyperbolic-like delayed luminescence relaxation<sup>15</sup>, (4) hyperbolic oscillations around the relaxation curve<sup>15,35</sup>, (5) coupling of the different modes<sup>17</sup>, (6) the squeezing into both branches of minimum uncertainty wave packets, i.e. minimization of position and of momentum uncertainty<sup>34</sup>, and (7) the strong correlation to DNA dynamical states<sup>22</sup>.

From a biological point of view, for instance, (1) the mitotic figures<sup>19</sup>, (2) the “interference structure” of biophoton emission from daphnia<sup>26</sup>, (3) the qualitatively different photon emission and reemission of tumor tissue and normal tissue<sup>15</sup>, and (4) the

correlation to growth and differentiation of cells<sup>36</sup>, will all become understandable.

The mean value of the number  $n$  of photons of energy  $h\nu$  of a homogeneous electromagnetic field with amplitude  $E_0$  can be estimated by equating the energies  $n h\nu$  of the photons and  $\epsilon_0/(8\pi) |E_0|^2 V$  of the field, where  $\epsilon_0$  is the dielectric constant and  $V$  the volume of the field. For one photon in the optical range of, say, 3 eV, one gets a field amplitude on the order of  $10^6$  V/cm over a volume of a cell of about  $10^{-9}$  cm<sup>3</sup>. This means that in the case that the electric field amplitudes of the cavity modes which stabilize the mitotic figures are in the range of  $10^6$  V/cm (corresponding to about the membrane field components), only one photon in the optical range would suffice for this effect. In other words: The low intensity of biophoton emission may well reflect its biological functions in cells, as for instance stabilization of the migration of the biomolecules, transportation of the angular momentum for rotating the DNA during replication or transcription, but also provision of the chemical reactivity of about  $10^5$  reactions per cell and per second, always at the right time and at the right place. The resonators model is one of the most powerful approaches for understanding biophoton emission. Actually, living systems may be looked upon as the most stable forms of matter through use of the storage of sunrays. To optimize what we call life, the gradient between the high temperature of the sun and the low one of the earth could be a necessary condition of life, particularly the prolongation of the entropy increase of light into heat, which means optimization of the storage capacity for sunlight. Photosynthesis as the process providing the elementary food supply of plants is a striking example. Let us remember that here also there is a clear connection between the resonator value of a cavity and its information content, pointing to a key understanding of biological systems in terms of informational rather than of energetic “engines,” and second, that the resonators may develop nonlinear capacities just because of their low photon emission. The deviation from the classical  $Q$ -value of the typical resonator may then take the form

$$Q^* = Q/(1-C) \quad \dots (1)$$

where  $Q^*$  is the resonator value of the quantum coherent resonator,  $Q$  the value of the classical “chaotic” resonator,  $C$  describes the ratio of a quantum coherent energy distribution of the resonator

to the totally available (chaotic+coherent) energy. This kind of resonator may develop rather high storage time ( $Q^*/Q \rightarrow \infty$  for  $C \rightarrow 1$ ), but may be able to emit or to remove photons actively for  $C > 1$ . It also describes Bose-condensation-like phenomena as Fröhlich has postulated. This can be seen in the following way: Take the Bose-Einstein distribution of the spectral photon density (number of photons per units of volume and wavelength  $\lambda$ ) at temperature  $T$

$$N(\lambda) = 8\pi/\lambda^4 \cdot 1/(\exp((\varepsilon-\mu)/(kT))-1) \quad \dots (2)$$

where  $\varepsilon = hc/\lambda$  is the photon energy and  $\mu$  the chemical potential, and  $k$  is the Boltzmann constant. The chemical potential is defined as  $\mu = -T(\partial S/\partial n)_{E,V}$  where  $dS$  is the entropy change through absorption of a photon. Fig. 2 tells us that the absorption of a biophoton by the multiplier outside of the system ( $dn < 0$ ) leads to an increase of the entropy of the system, and consequently to a value  $\mu > 0$ . In the case that there is no entropy loss by thermal noise, we then have  $\mu = \varepsilon$ . In the real case we may write

$$\mu = \varepsilon - kT \ln W \quad \dots (3)$$

where  $W$  corresponds to the thermodynamical probability of the photons under investigation. Insertion into Eq. (2) results in

$$N(\lambda) = 8\pi/\lambda^4 \cdot 1/(W-1) \quad \dots (4)$$

Now we see clearly the Bose condensation effect of a Fröhlich mode according to  $W \rightarrow 1$  as well as the connection to the corresponding value  $C$  in Eq. (1).  $C = 1$  provides that the whole energy of the system with the exception of that of classical currents belongs to a coherent field. In that case we get a resonance-like absorption of photons in the mode  $W \rightarrow 1$ . In the case that we include the possibility of "squeezed" light, we may even describe removal of photons by  $W < 1$  or the extension of  $W$ , where the thermodynamical potency of the photon field corresponds to the vanishing chemical potential according to (3).

$$\ln W = \varepsilon/(kT) \quad \dots (5)$$

In that case we again have the spectral intensity of thermal radiation.

However, the average spectral intensity of biophoton emission is a further indicator of its real nature.  $W$  turns out to be rather constant and independent of the wavelength (see Fig. 16). For all biological systems one finds the order of magnitude of  $W$  in the band between  $10^{-17}$  and  $10^{-23}$  which is certainly far from thermal equilibrium. This constancy of  $W$  (or  $f = 1/(W-1)$ ) invites us to postulate that

- (1) living systems keep this rule  $W = \text{constant}$  over the whole spectral range up to a limiting frequency  $\nu_0$ , corresponding to a cutoff wavelength  $\lambda_0 = c/\nu_0$ , where  $c$  is the velocity of light.
- (2)  $W$  is adjusted in living systems in such a way that in a biological equilibrium state—which is far from thermal equilibrium—the whole available thermal spectral energy is equally distributed over all the available resonance modes of the biological system.

These statements (Fig. 16) provide that the biological system is some kind of an information engine that transforms heat energy into the occupation of coherent modes by use of food supply, i.e. sunrays. It optimizes its energy content by adjusting it to thermal boundary conditions of a heat bath, probably by isoenthalpic processes. At the same time this balance between the thermal energy density and the nonthermal occupation of the modes explains the continuity of biological evolution from equilibrium systems to open ones.

Consequently, we enunciate

$$\begin{aligned} 1/\langle W \rangle \int 8\pi/\lambda^4 (hc/\lambda) d\lambda &= 2\pi/\langle W \rangle (hc/\lambda_0^4) \\ &= \int 8\pi/\lambda^4 (hc/\lambda) 1/(\exp(hc/(kT\lambda))-1) d\lambda \\ &= 8/15 \pi^5 (kT)^4/(hc)^3 \quad \dots (6) \end{aligned}$$

where  $\langle W \rangle$  is the average of  $W$  over all the modes of the biological resonator system, and the integration on the left hand side runs from  $\infty$  to  $\lambda_0$  and not as on the right hand side from  $\infty$  to 0. Eq. (6) provides the relation between  $\langle W \rangle$  and the cutoff wavelength  $\lambda_0$ , that is:

$$W = 15/4 \pi^4 (hc/(kT\lambda_0))^4 \quad \dots (7)$$

We know that the spectral biophoton intensity is on the order of a few up to some hundred photons per  $\text{cm}^2$ , and  $s$  in the range from 200 nm to 800 nm, corresponding to a  $\langle W \rangle$  value between, say,  $10^{-17}$  to  $10^{-23}$  (see Fig. 4). Insertion into Eq. (7) teaches us that the corresponding  $\lambda_0$  is on the order of Angstrom units. It fits into our images of the smallest size of a resonating structure within a biological system, since the smallest possible resonators are of this order of magnitude, i.e. the distances between neighbored base pairs of the DNA. At the same time it supports again the exciplex model of biological evolution which has already been discussed several times.

A corresponding model concerns the adiabatic or isoenthalpic expansion of a photon gas, initiated by

sunrays in the smallest possible resonance cavities of a biological system and expanding more and more to the bigger-sized ones by the  $f$  (or  $W$ )=const.-rule down to a final thermal degradation in the ULF ranges, where with increasing evolutionary states the number of resonator modes increase by shifting down also toward lower and lower boundary frequencies. According to the noise theory of Louisell the extension of resonating frequencies protects more and more against thermal damping of a coherent system.

A further important point about the thermodynamics of biophoton emission is that the entropy  $S$  of the open system with  $\mu = \varepsilon - kT \ln W$  becomes independent of temperature  $T$ .  $S$  may even increase to values that are higher than that of thermal equilibrium systems, because the number of modes increases with  $1/(\lambda_0)^3$ . A straightforward calculation shows that the entropy is higher than the equilibrium state as soon as

$$W > 15/4 \pi^{-4} (hc/(kT\lambda_0))^3 \quad \dots (8)$$

Comparison with Eq. (7) shows that this case is generally fulfilled as soon as the system relaxes to its steady state. However, as soon as the modes are coupled, the number of modes may decrease in such a way that the entropy becomes much lower than that of the equilibrium state. Theoretically it may even reach the value 0. This very important property of the system to vary between a state of higher entropy than the thermal equilibrium state and one of lower entropy explains both the stability and sensitivity of biological systems that has been discussed elsewhere. At the same time, this result provides a fundamental explanation of what we call homeostasis.

While the spatial pattern of the electromagnetic resonance modes is determined by Maxwell's equations, the dynamics is subjected to quantum theory. One should note that even if the light in cells originated from a chaotic field, the volume of a cell is always within the coherence volume of chaotic light. The coherence length of chaotic light from electronic transitions of molecules is the lifetime  $\tau$  times the velocity of light and even for allowed optical transitions is much longer than the typical dimensions of a cell. This means that it is practically impossible that photons lose their phase information over the distance of a biological cell. Consequently, it is impossible to determine the molecular source of biophotons, since even in the case of chaotic states (which may certainly contribute to the whole emission) the whole cell is subject to the coherence

volume, and the localization of the origin of a photon is not possible within this range. In other words, biophotons are in any case characterized by their relatively high degree of coherence within the volume of their activities. However, there are more than indications that the origin of biophotons is a fully coherent field, following the equation

$$a |\alpha\rangle = \alpha |\alpha\rangle \quad \dots (9)$$

where  $a$  is the annihilation operator, and  $|\alpha\rangle$ ,  $\alpha$  the coherent state and its eigenvalue (field amplitude), respectively.

That biological systems are governed by quantum coherent states has been shown by (1) the Poissonian photocount statistics of biophoton emission which is a necessary condition of a fully coherent field and (2) the hyperbolic-like relaxation of delayed luminescence which is a sufficient condition of a fully coherent field under ergodic conditions. The ergodic condition, on the other hand, has been proven by the Poissonian distribution of photocounts even during relaxation, which holds only if the field is ergodic. Thus, there is evidence that the biophoton field of a biological system is a fully coherent field. In turn, the hyperbolic oscillations around the delayed luminescence relaxation can be understood only in terms of couplings of coherent states. No nonliving system is known that displays hyperbolic oscillations after light-induced re-emission.

However, as we now know, even squeezed states are possible. They may be squeezed in the position space  $\langle q \rangle$  or in the momentum space  $\langle p \rangle$ , always satisfying the minimum uncertainty relation.

$$(\Delta p \Delta q) = h/2 \quad \dots (10)$$

In contrast to a coherent state, both  $\Delta p$  and  $\Delta q$  are variable in a squeezed state, whereby keeping (10) valid either  $\Delta p \rightarrow 0$  and  $\Delta q \rightarrow \infty$  or  $\Delta q \rightarrow 0$  and  $\Delta p \rightarrow \infty$ .

Evidence has been shown by sub-Poissonian photocount statistics (for  $\Delta p \rightarrow 0$ ,  $r > 0$ ) in the case of an illuminated leaf and of ultraweak photon emission from dinoflagellates. The ordinary bioluminescence of all luminescent biological systems is triggered in general by biophotons which are at least in the case of dinoflagellates able to split into squeezed states with squeeze factors  $r > 0$  ( $\Delta p \rightarrow 0$ ) and  $r < 0$  ( $\Delta q \rightarrow 0$ ). This happens at the same time that the average photon number becomes smaller than 1. Further experimental work on squeezed states is still on the research program of the IIB.

## References

- 1 Gurwitsch A, Über Ursachen der Zellteilung, *W Roux' Arch*, 52 (1922).
- 2 Gurwitsch A, *Die Mitogenetische Strahlung. Monographien aus dem Gesamtgebiet der Physiologie der Pflanzen und der Tiere* (J. Springer, Bd. 25, Berlin) 1932.
- 3 Reiter T & Gabor D, Zellteilung und Strahlung, *Sonderheft der Wissenschaftlichen Veröffentlichungen aus dem Siemens-Konzern* (J. Springer, Berlin) 1928.
- 4 Ruth B, *Experimenteller Nachweis Ultraschwacher Photonemission aus biologischen Systemen*, Dissertation, Universität Marburg, 1977.
- 5 Slawinski J, Biophoton emission (multi-author review), *Experientia*, 44 (1988) 559.
- 6 Inaba H, in Biophoton Emission (multi-author review), *Experientia*, 44 (1988) 550.
- 7 Boveris A, Varsavsky A I, Da Silva S G & Sanchez R A, *Photochem. Photobiol*, 38 (1983) 99.
- 8 Quickenden T I & Tilbury R N, Growth dependent luminescence from cultures of normal and respiratory deficient, *Photochem Photobiol*, 38 (1983) 337.
- 9 Zhuravlev A I (ed.), *Biochemiluminescence*, USSR Academy of Sci. and Moscow Soc. *Nature*, vol. 58, (Nauka Publ. House, Moscow) 1983, 210.
- 10 Seliger H H, in *Chemiluminescence and bioluminescence*, edited by Cormier M J, Hercules D M and Lee J (Plenum Press, New York) 1973, 461.
- 11 Popp F A, Molecular base of malignancy, in *Molecular aspects of carcinogenesis*, edited by Deutsch E, Moser K, Rainer H and Stacher A (Thieme Verlag, Stuttgart) 1976, 47.
- 12 Popp F A, Einige Möglichkeiten für Biosignale zur Steuerung des Zellwachstums, *Arch Geschwulstforschung*, 44 (1974) 295.
- 13 Ruth B & Popp F A, Experimentelle Untersuchungen zur ultraschwachen Photonemission biologischer Systeme, *Z. Naturforsch.*, 31e (1976) 741.
- 14 Ruth B, Experimental investigations on ultraweak photon emission, in *Electromagnetic Bio-Information*, edited by Popp F A, Becker G, König H L and Peschka W (Urban & Schwarzenberg, München) 1979, 107.
- 15 Popp F A, Ruth B, Bahr W, Böhm J, Grass P, Grolig G, Rattemeyer M, Schmidt H G & Wulle P, Emission of Visible and Ultraviolet radiation by active biological systems, *Collective Phenomena*, 3 (1981) 187.
- 16 Popp F A, Gu Q & Li K H, Biophoton emission: Experimental background and theoretical approaches, *Modern Physics Letters B*, 8 (1994) 1269.
- 17 Popp F A, Li K H & Gu Q (eds.), *Recent advances in biophotons research and its applications*, (World Scientific, Singapore) 1992.
- 18 Chang J J & Popp F A, Biological organization: A possible mechanism based on the coherence of "Biophotons", in *Biophotons*, edited by Chang J J, Fisch J and Popp F A (Kluwer Academic Publishers, Dordrecht-Boston-London) 1998, 217.
- 19 Popp F A, Coherent photon storage of biological systems, in *Electromagnetic Bio-Information*, edited by Popp F A, Becker G, König H L and Peschka W (Urban & Schwarzenberg, München) 1979, 123.
- 20 Popp F A, Nagl W, Li K H, Scholz W, Weingärtner O & Wolf R, Biophoton emission, New evidence for coherence and DNA as source, *Cell Biophys*, 6 (1984) 33.
- 21 Slawinski J & Popp F A, Temperature Hysteresis of Low Level Luminescence from Plants and its Thermodynamical Analysis, *J Plant Physiol*, 130 (1987) 111.
- 22 Rattemeyer M, Popp F A & Nagl W, Evidence of photon emission from DNA in living systems, *Naturwissenschaften*, 11 (1981) 572.
- 23 Chwirot B, New Indication of possible role of DNA in ultraweak photon emission from biological systems, *J Pant Physiol*, 122 (1986) 81.
- 24 Popp F A & Li K H, Hyperbolic relaxation as a sufficient condition of a fully coherent ergodic field, *Int J Theor Phys*, 32 (1993) 1573.
- 25 Dicke R H, Coherence in spontaneous radiation processes, *Phys Rev*, 93 (1954) 99.
- 26 Galle M, *Untersuchungen zum dichte-und zeitabhängigen Verhalten der ultraschwachen Photonemission von pathogenetischen Weibchen des Wasserfloh Daphnia magna*, Dissertation (Universität Saarbrücken, Zoologie) 1993.
- 27 Galle M, Neurohr R, Altmann G, Popp F A & Nagl W, Biophoton emission from *Daphnia magna*: A possible factor in the self-regulation of swarming, *Experientia*, 47 (1991) 457.
- 28 Popp F A & Chang J J, Mechanism of interaction between electromagnetic fields and living organisms, *Science in China (C)*, 43 (2000) 507.
- 29 Schamhart D H J & van Wijk R, Photonemission and the degree of differentiation, in *Photon emission from biological systems*, edited by Jezowska-Trzebiatowska B, Kochel B and Slawinski J (World Scientific, Singapore) 1987, 137.
- 30 Scholz W, Staszkiwicz U, Popp F A & Nagl W, Light stimulated ultraweak photon reemission of human amnion cells and Wish cells, *Cell Biophys*, 13 (1988) 55.
- 31 Popp F A, Chang, J J, Gu Q & Ho M W, Nonsubstantial biocommunication in terms of Dicke's theory, in *Bioelectrodynamics and Biocommunication*, edited by Ho M W, Popp F A and Warnke U (World Scientific, Singapore) 1994, 293.
- 32 Vogel R & Süßmuth R, A model for the generation of low level chemiluminescence from microbiological growth media and its depletion by bacterial cells, *Bioelectrochem Bioenerget*, 45 (1998) 93.
- 33 Bajpai R P, Coherent nature of the radiation emitted in delayed luminescence of leaves, *J Theor Biol*, 198 (1999) 287.
- 34 Popp F A, Chang J J, Herzog A, Yan Z & Yan Y, Evidence of non-classical (squeezed) light in biological systems, *Physics Lett A*, 293 (2002) 98.
- 35 Popp F A & Yan Y, Delayed luminescence of biological systems in terms of coherent states, *Physics Lett A*, 293 (2002) 93.
- 36 Nagl W & Popp F A, A physical (electromagnetic) model of differentiation, *Cytobios*, 37 (1983) 45, 71.